

Barriques da 225/300 - Tonneaux da 350/500 lt

Uso:

Viene usato alla base delle cataste, è dotato di tappi in p.v.c. per migliorare l'appoggio al pavimento senza intaccarlo.

Materiale:

- Alluminio anodizzato argento

Use:

It is designed to be used at the stack bottom, fitted with rubber pugs for a better stability and no floor damage.

Material:

- Anodized aluminium, silver color

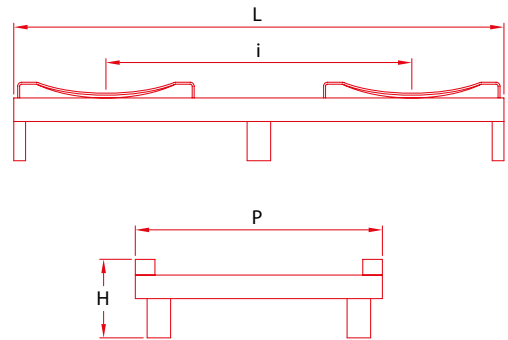

Barriques da 225/300 lt

LUNGHEZZA · LENGTH	(L)	1.250 mm
INTERASSE · WHEELBASE	(i)	790 mm
LARGHEZZA · WIDTH	(P)	630 mm
ALTEZZA · HEIGHT	(H)	217 mm
TARA · TARE	(Kg)	9,5
PORTATA max · FLOW	(Kg)	3.000

Tonneaux da 350/500 lt

LUNGHEZZA · LENGTH	(L)	1.470 mm
INTERASSE · WHEELBASE	(i)	1.000 mm
LARGHEZZA · WIDTH	(P)	790 mm
ALTEZZA · HEIGHT	(H)	220 mm
TARA · TARE	(Kg)	11,5
PORTATA max · FLOW	(Kg)	3.000



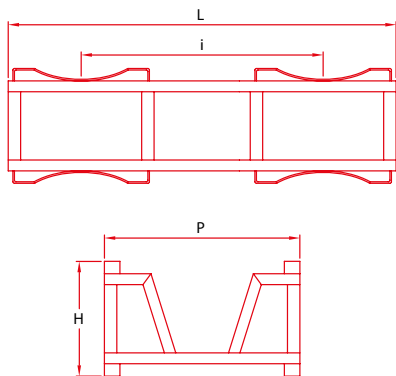

Barriques da 225/300 - Tonneaux da 350/500 lt

Uso:

È il più versatile . È stato studiato nella forma e nell'altezza per permettere un agevole accesso alla barrique sottostante per le varie lavorazioni di rabbocco, prelievi e batonnage.

Materiale:

- Alluminio anodizzato argento

Use:

It is the most important solution. Shape and height are designed to give an easy access to the barrel to work in place.

Material:

- Anodized aluminium, silver color

Tonneaux da 350/500 lt

LUNGHEZZA · LENGTH	(L)	1.470 mm
INTERASSE · WHEELBASE	(I)	1.000 mm
LARGHEZZA · WIDTH	(P)	790 mm
ALTEZZA · HEIGHT	(H)	358 mm
TARA · TARE	(Kg)	14
PORTATA max · FLOW	(Kg)	3.000



Barriques da 225/300 lt

Uso:

È stato studiato per poter movimentare le cataste anche con transpallet oltre che con carrello elevatore. Permette un agevole accesso alla barrique sottostante per varie lavorazioni di rabbocco, prelievi e batonnage.

Materiale:

- Alluminio anodizzato argento

Use:

It is designed for stacks to be moved with fork lift, also with fixed forks, and for having an easy access to the barrel to work the wine in place.

Material:

- Anodized aluminium, silver color

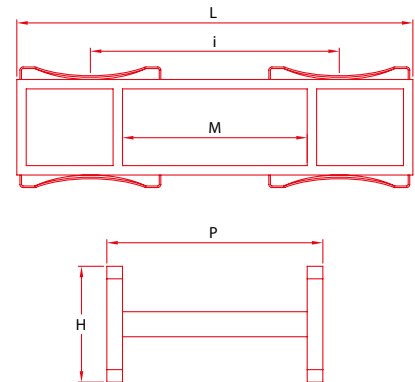

Barriques da 225/300 lt

LUNGHEZZA · LENGTH	(L)	1.265 mm
INTERASSE · WHEELBASE	(l)	790 mm
LARGHEZZA · WIDTH	(P)	690 mm
ALTEZZA · HEIGHT	(H)	387 mm
TARA · TARE	(Kg)	12
PORTATA max · FLOW	(Kg)	2.500
INTERASSE MONTANTE · FLOW	(M)	590 mm



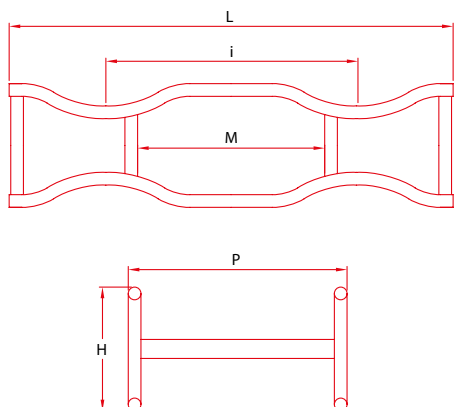

Barriques da 225/300 - Tonneaux da 350/500 lt

Uso:

È stato studiato per poter movimentare le cataste anche con transpallet oltre che con carrello elevatore. Permette un agevole accesso alla barrique sottostante per varie lavorazioni di rabbocco, prelievi e batonnage.

Materiale:

- Alluminio anodizzato argento

Use:

It is designed for stacks to be moved fork lift, also with fixed forks, and having an easy access to the barrel to work the wine in place.

Material:

- Anodized aluminium, silver color

Barriques da 225/300 lt

LUNGHEZZA · LENGTH	(L)	1.408 mm
INTERASSE · WHEELBASE	(I)	786 mm
LARGHEZZA · WIDTH	(P)	660 mm
ALTEZZA · HEIGHT	(H)	390 mm
TARA · TARE	(Kg)	12
PORTATA max · FLOW	(Kg)	3000
INTERASSE MONTANTE · FLOW	(M)	590 mm

Tonneaux da 350/500 lt

LUNGHEZZA · LENGTH	(L)	1.649 mm
INTERASSE · WHEELBASE	(I)	960 mm
LARGHEZZA · WIDTH	(P)	712 mm
ALTEZZA · HEIGHT	(H)	395 mm
TARA · TARE	(Kg)	14
PORTATA max · FLOW	(Kg)	3.000
INTERASSE MONTANTE · FLOW	(M)	680 mm



Barriques da 225/300 - Tonneaux da 350/500 lt

Uso:

È stato studiato per ridurre notevolmente i tempi di movimentazione delle barriques. Permette un'efficace batonnage, in quanto la barrique può ruotare di 360°. Consente di eseguire tutte le operazioni di riempimento, svuotamento, colmataura, lavaggio in loco senza rimuovere la barriques.

Materiale:

- Alluminio verniciato a polveri, Rosso Ral 3005

**CONSTRUITO TOTALMENTE IN ALLUMINIO
RUOTE CON CUSCINETTO E VITERIA IN ACCIAIO INOX**

Use:

It has been studied to considerably reduce and simplify the movement of the barriques. It enables an efficient batonnage due to the fact that the barriques can rotate around 360°. It allows all the operations of filling, emptying and cleaning in place to be carried out without removing the barriques.

Material:

- Polyester powder coated aluminium, Red Ral 3005

**CONSTRUCTED TOTALLY IN ALUMINIUM,
WHEELS WITH BEARING AND LIVES IN STAINLESS STEEL**



Vaschetta raccogli liquido - Drip tray



Slitta per inserimento barriques - Insert slide tool



**SISTEMA DI REGOLAZIONE
DELLA RUOTA BREVETTATO**

**PATENTED WHEEL
ADJUSTMENT SYSTEM**



BARRIQUES DA 225 LT

_Piramide

B= 1670



B= 2650



B= 3630



B= 4610



B= 5590



H= 868

H= 1531

H= 2221

H= 2911

H= 3601

_Verticale

B= 1843



B= 2823



B= 3803



B= 4783



B= 5763



H= 2221

H= 2911

H= 3601

TONNEAUX DA 350 LT

_Piramide

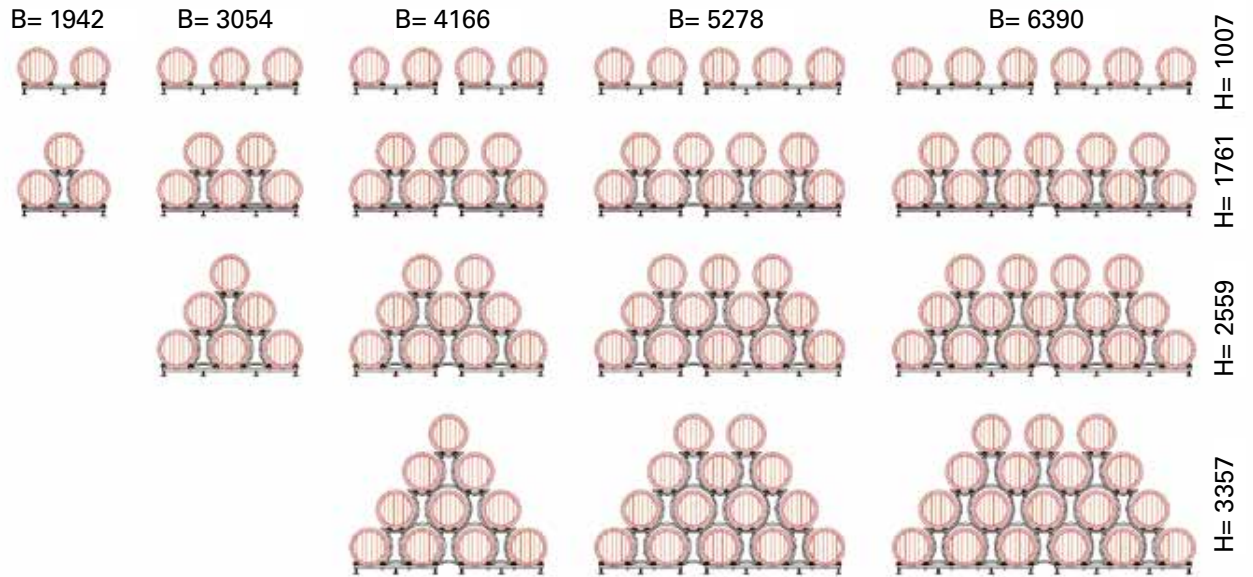

_Verticale

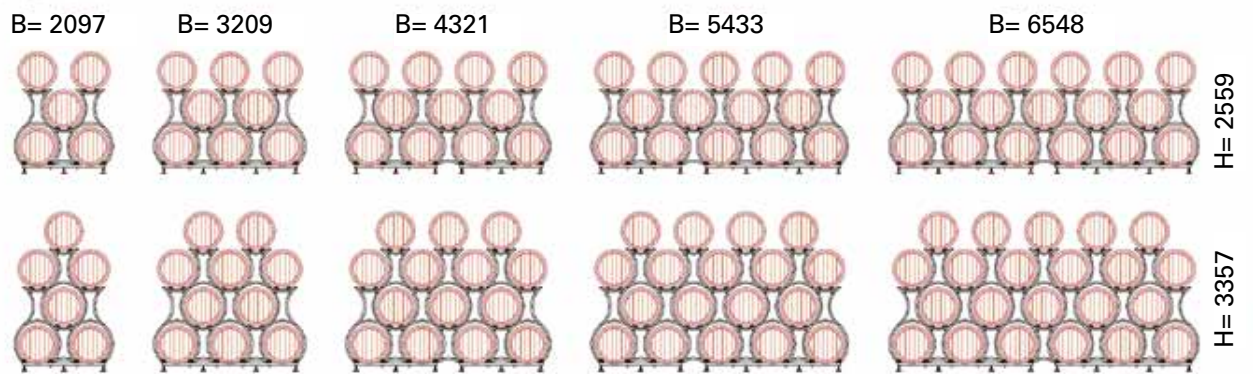

TONNEAUX DA 500 LT

_Piramide

B= 2214



B= 3478

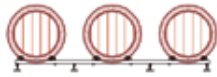

B= 4742



B= 6006

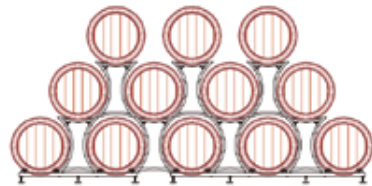
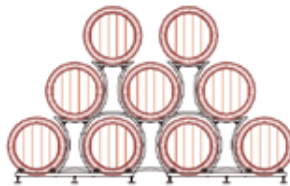
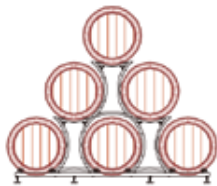
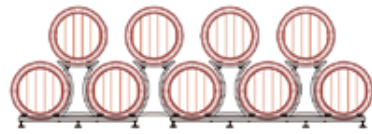
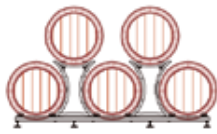

H= 1109

H= 1977

H= 2899

_Verticale

B= 2356

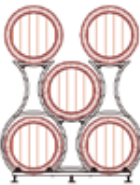

B= 3620

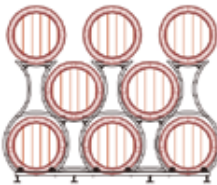

B= 4884

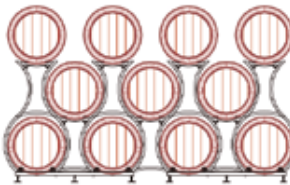

B= 6148

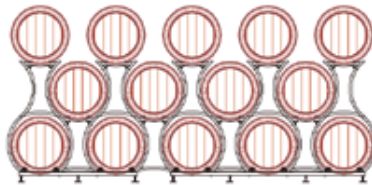

H= 2899

Barriques da 225/300 - Tonneaux da 350/500 lt

Uso:

Nasce dall'esperienza del
offre gli stessi vantaggi, rendendo più pratico l'accesso alla
barriques sottostante, inoltre dà la possibilità anche di ese-
guire cataste circolari.

Materiale:

- Alluminio verniciato a polveri, grigio scuro bucciato

Use:

*Created from years of experience with
this system offers the same advantages but with
easier access to the lower level barrels. This system also
makes it possible to build circular stacking arrangements.*

Material:

- Polyester powder coated aluminium, dark gray dimpled



Esempio catasta diritta - Example of linear stacking arrangement



Esempio catasta circolare - Example of curved stacking arrangement





BARRIQUES DA 225 LT

_Piramide

B= 1580



B= 2470



B= 3360



B= 4250



B= 5140



H= 1697



H= 2397

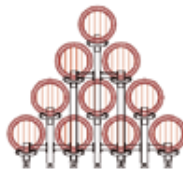

H= 3097

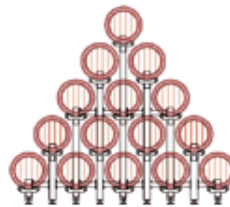

H= 3797

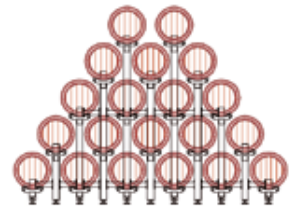

_Verticale

B= 1580



H= 2397

B= 2470



H= 3097

B= 3360

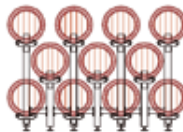

H= 3797

B= 4250

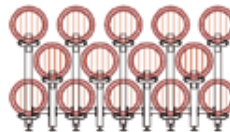

B= 5140

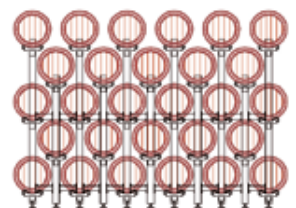
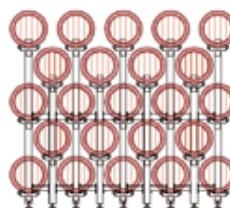
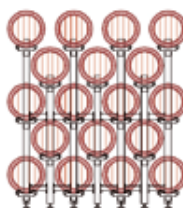
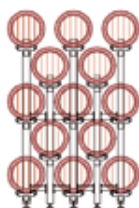
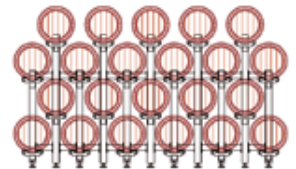
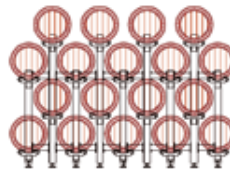
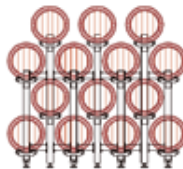
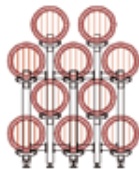
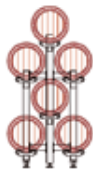

TONNEAUX DA 300 LT

_Piramide

B= 1780



B= 2800



B= 3820



B= 4840



B= 5860



H= 1775



H= 2475



H= 3175

_Verticale

B= 1780



B= 2800



B= 3820



B= 4840



B= 5860



H= 2475



H= 3175

ESEMPI DI ACCATASTAMENTO - *EXAMPLES OF STACKING ARRANGEMENTS*

TONNEAUX DA 500 LT

_Piramide

B= 2090



B= 3230



B= 4370

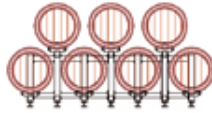

B= 5510

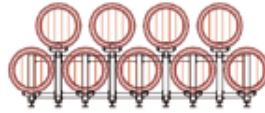

B= 6650

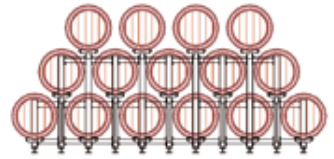
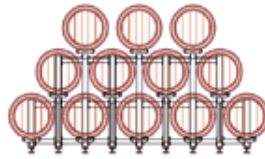
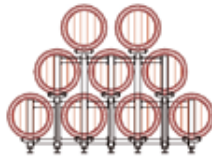

H= 2149

H= 3035



ROTATIVO SINGOLO TRANSPALLET 225/500 LT



SOLLEVATORE BARRIQUES - BARREL STACKER

